



M-POWER-4T

AC POWER & DATA CONNECTIVITY SOLUTION
4T-AUCX-BZATP

Distributed by



Mormax Company, Inc.
8 Westchester Plaza
Elmsford, NY 10523

914-699-0101
sales@mormax.com
mormax.com

Metro Light & Power's line of power & data solutions offers sophisticated design elements combined with greater ease of installation. Streamlined and low-profile, enhanced by side-exiting cords, our outlets advance the industry with their cutting-edge look and feel. We believe flexibility is key, and we provide a variety of mounting options, including the ability to mount in limited spaces. Our outlets are available in many finishes and configurations, in addition to a custom color and finish capability for our clients.

Trim Plate Finish: **STANDARD BRONZE (ABS)**
Custom Finishes Available M-POWER-4T-AUCX-BZATP

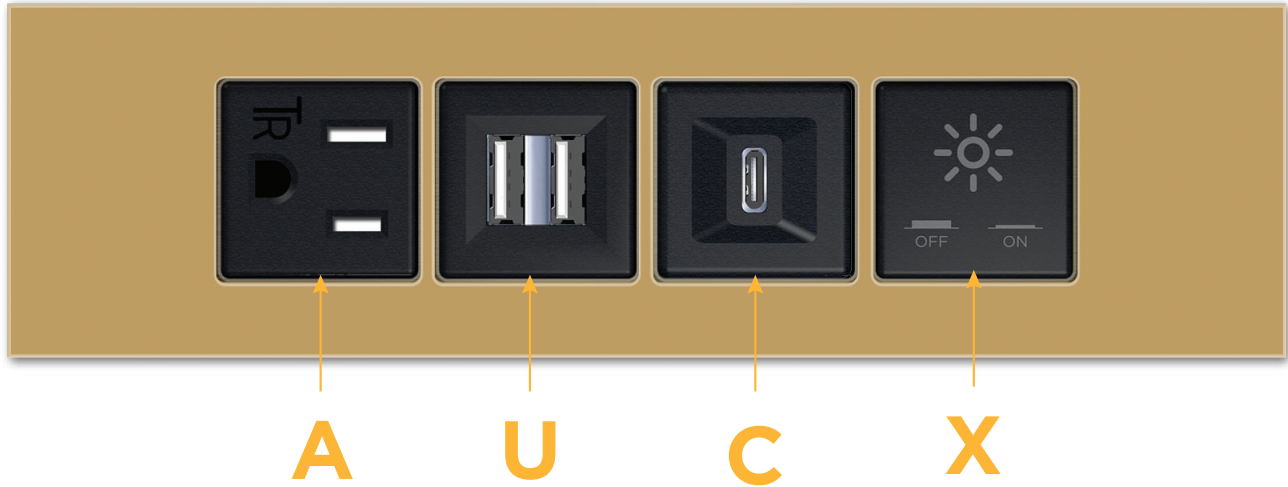

Features:

Module/Port Options:

- A** Tamper Resistant AC Receptacle
- U** Double USB (Fast Charging Ports - Rated for 3.2A)
- H** HDMI
- 6** CAT 6
- 12** RJ 12
- X** Switched AC
- Y** 3-Way Switch
- C** USB-C (27W High Speed Charging Port)
- Z** USB-C (18W High Speed Charging Port)
- R** Switched AC (Rocker Switch)

Plug:

- Supplied with Low Profile Flat 45° Angle 120 VAC Plug
- Optional Standard Straight 120 VAC Plug
- Optional Straight 120 VAC Pass-through Plug

Shown in Standard Bronze (ABS) Plate, featuring 1 Tamper Resistant AC, 1 Double USB Charging Port, 1 USB-C Charging Port, and 1 Switched AC.

- **CLEAN, COMPACT DESIGN**
- **STREAMLINED**
- **LOW PROFILE**
- **SIDE-EXITING CORDS**
- **PLUG & PLAY**
- **18W HIGH SPEED USB-C CHARGING FOR ALL DEVICES**
- **3.2A HIGH SPEED USB CHARGING FOR ALL DEVICES**
- **6' AC CORD & PLUG (FLAT PLUG STANDARD)**
- **CUSTOMIZABLE CONFIGURATIONS AND FINISHES**
- **UL LISTED FOR MOUNTING IN FURNITURE**
- **15A**



M-POWER-4T

AC POWER & DATA CONNECTIVITY SOLUTION
4T-AUCX-BZATP

Distributed by



Mormax Company, Inc.
8 Westchester Plaza
Elmsford, NY 10523

☎ 914-699-0101
✉ sales@mormax.com
🌐 mormax.com

Specs:

Modules/Ports:

- A** Tamper Resistant AC Receptacle
- U** Double USB (Fast Charging Ports - Rated for 3.2A)
- Z** USB-C (18W High Speed Charging Port)
- X** Switched AC

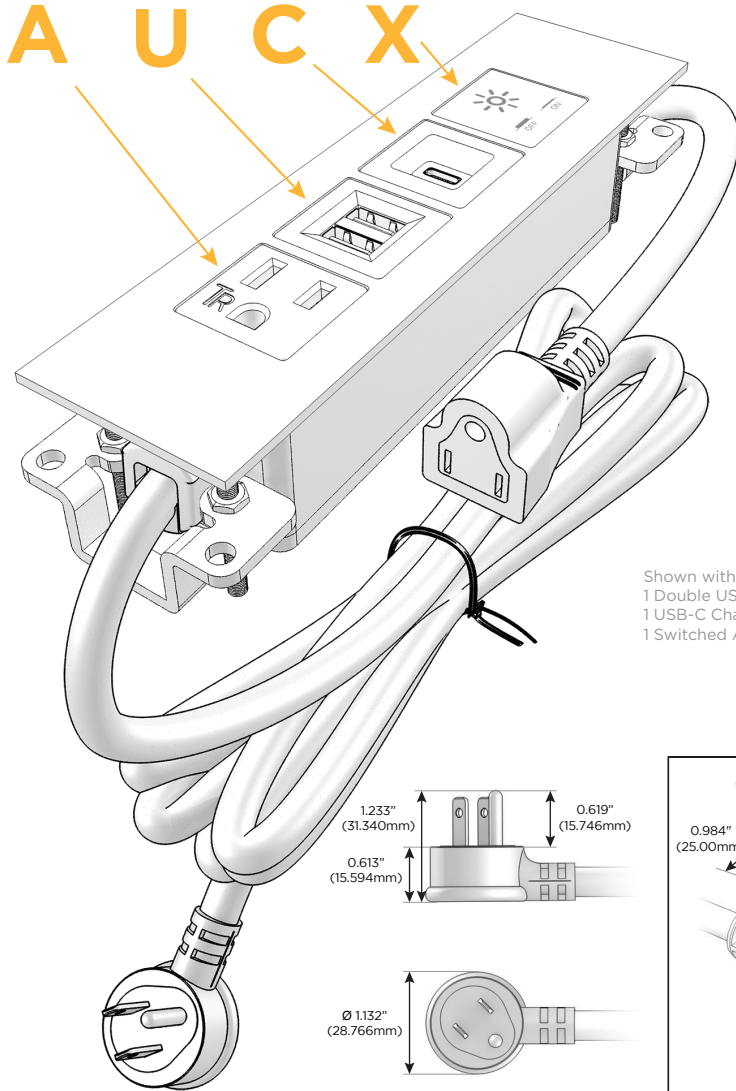

Shown with 1 Tamper Resistant AC,
1 Double USB Charging Port,
1 USB-C Charging Port,
1 Switched AC.

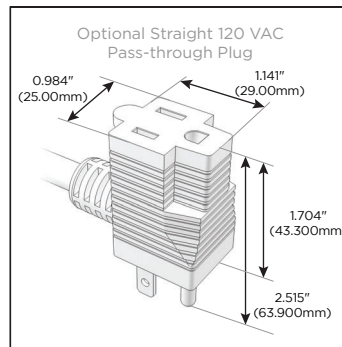
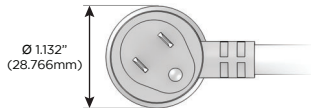
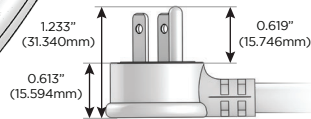

TOP

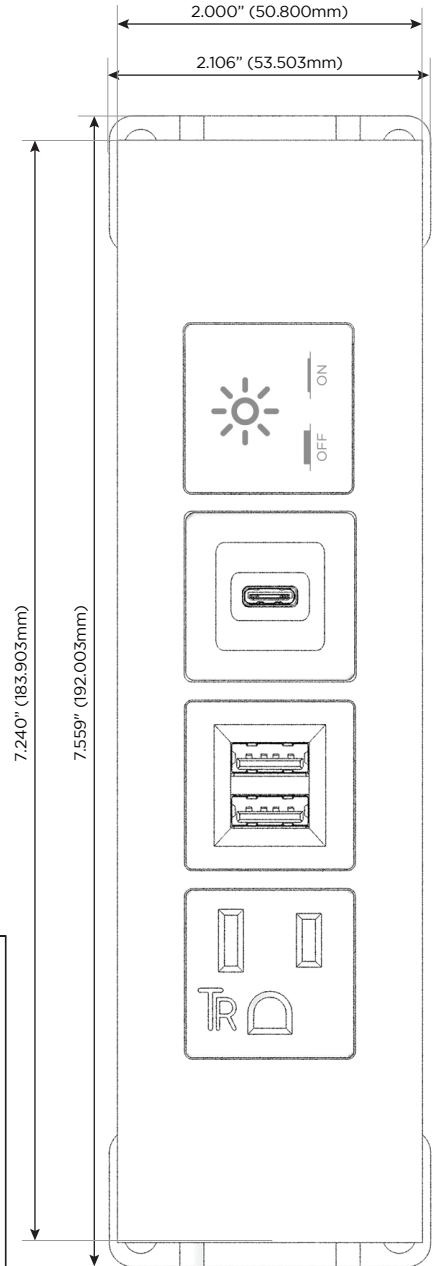

END

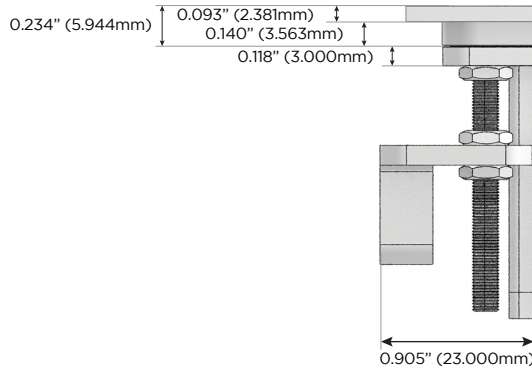
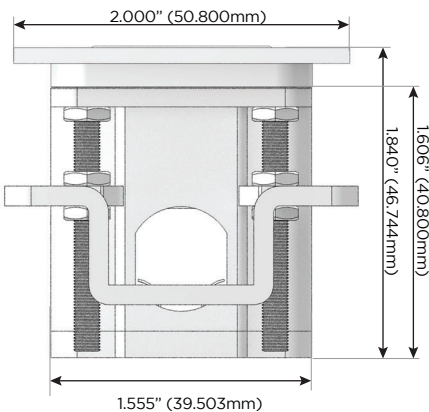

SIDE

